

COMPUTHERM E300

a programmable digital Wi-Fi thermostat for radiator and underfloor heating systems



Instruction Manual



COMPUTHERM E Series

TABLE OF CONTENTS

1. A general description of the thermostat	5
2. Important warnings and safety recommendations	6
3. Information appearing on the display of the thermostat	9
4. Functions accessible in the phone application	10
5. Location of the thermostat	11
6. Connection and installation of the thermostat and putting it into operation	11
6.1. Connection of the device(s) to be controlled	12
6.2. Connecting the floor temperature sensor	15
6.3. Connection to the electrical network	16
6.4. Mounting the thermostat	17
6.5. Installing the application	18
6.6. Connecting the thermostat to a Wi-Fi network	18
6.7. Connecting the thermostat to a user account	19
6.8. Controlling the thermostat by multiple users	20
7. Basic settings	21
7.1. Renaming the thermostat assigned to the application	21
7.2. Disabling further connections of the thermostat assigned to the application	22
7.3. Deleting the thermostat assigned to the application	22
7.4. Setting the day and time	23
7.5. Locking operating buttons	24

8. Operation-related settings	25
8.1 Selecting the temperature sensor	28
8.2. Setting floor temperature limit and corresponding switch sensitivity	29
8.3 Calibration of the temperature sensor	30
8.4 Antifreezing	30
8.5. Memorizing settings in the event of a power failure	30
8.6 Restoring default setting	31
9. Basic operation of the thermostat	32
10. Switching between ON and OFF positions and modes of the device	33
10.1. Manual mode	34
10.2. Programmed auto mode	35
10.2.1 Description of the programmed mode	35
10.2.2. Description of the steps of programming	36
10.2.3. Modifying temperature until the next switch in the program	39
11. Practical advices	39
12. Technical data	42

1. A GENERAL DESCRIPTION OF THE THERMOSTAT

COMPUTHERM E300 Wi-Fi thermostat is a switching device that can be operated by a smartphone or tablet via Internet, and we especially recommend it for controlling heating or cooling systems. It can be easily connected to any gas boiler having a two-wire thermostat connection point and to any air conditioning apparatus or electrical apparatus, regardless of whether they have a 24 V or 230 V control circuit.

The device can be easily controlled via both Internet and touch button interface, and its operating conditions can be checked continuously.

The device also facilitates automatic control on the basis of temperatures and times. Several thermostats that are put into operation at different locations can be registered to the same account and controlled. The thermostat has two potential free relays which switch simultaneously therefore it is able to control two independent apparatuses.

COMPUTHERM E300 Wi-Fi thermostats can be used to control:

- gas boilers
- an existing heating/cooling system remotely
- electric water heaters

- solar systems
- certain groups of other electric devices

With the help of the product the heating/cooling system of your flat, house or holiday home can be made controllable from any place and at any time. This product is especially useful when you do not use your flat or house according to a predefined schedule, you leave your home for an uncertain period of time during the heating season or you intend to use your holiday home during the heating season as well.

The thermostat is especially suitable for controlling underfloor heating systems owing to the connectable floor temperature sensor.

The two parallel operating relays incorporated into the device simply ensure that the thermostat can activate or turn on or off a pump and a zone valve (see **Figure 5**), in addition to starting up the boiler. Thus, using several **COMPUTHERM E300** type Wi-Fi thermostats, a heating system can be easily divided into zones without a separate zone control system.

2. IMPORTANT WARNINGS AND SAFETY RECOMMENDATIONS

- Before starting to use the device, please study carefully the instructions for use and follow strictly the instructions therein.

- The thermostat was designed for business or household (not industrial) use, and can be used to control any electric device while keeping in mind the maximum output load of the thermostat.
- Before starting to use the thermostat, make sure that the Wi-Fi network is reliably accessible at the place where you intend to use the apparatus.
- This device has been designed for indoor use. Do not use it in a humid, dusty or chemically aggressive environment.
- This device is a thermostat that can be controlled via a wireless Wi-Fi network. To prevent jamming, keep it away from such electric equipment which may interfere with wireless communications.
- The manufacturer will assume no responsibility for any possible direct or indirect damages or income losses incurring during the use of the device.
- The device will not work without power supply, but the thermostat is able to memorize settings. In case of power failure (outage) it can resume operation without any external intervention after the power supply is restored, provided that this option has been chosen among settings (see **Chapter 10**). If you intend to use the device in an environment where power

outages occur frequently, for safety purposes we propose you to control proper operation of the thermostat regularly.

- **Before actually starting to control the device connected to the thermostat, make sure that the device is perfectly functioning when it is controlled by the thermostat and it can be operated reliably.**
- The software of the thermostat and the telephone application is constantly upgraded and updated. For proper operation please check regularly whether there is any accessible software or telephone application update, and always use their latest version! Due to constant updates it is possible that some functions of the device and the applications operate and appear in a way other than described in these instructions for use.

3. INFORMATION APPEARING ON THE DISPLAY OF THE THERMOSTAT

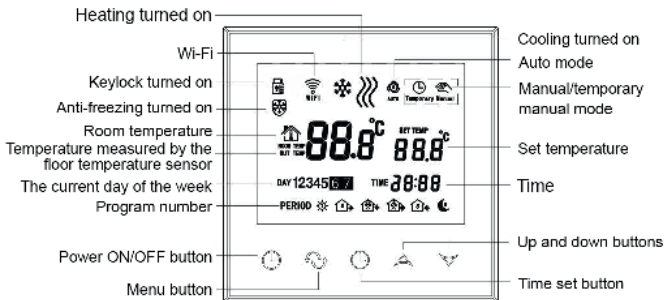

Figure 1

4. FUNCTIONS ACCESSIBLE IN THE PHONE APPLICATION

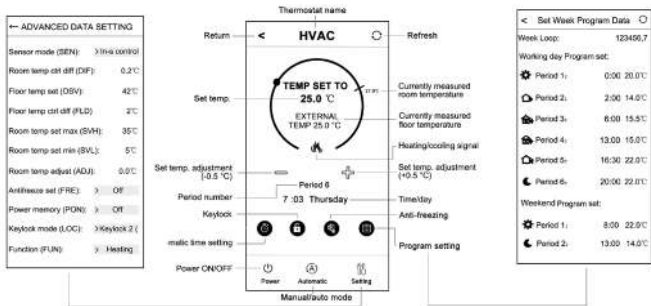

Figure 2

5. LOCATION OF THE THERMOSTAT

It is expedient to install the thermostat on the wall of a room used regularly or for a prolonged stay, so that it is located in the direction of natural air movement in the room, but do not expose it to draughts of air or extreme heat effects (e.g. solar radiation, refrigerator or chimney). Its optimal position is at a height of 0.75 - 1.5 m from the floor level.

The product has been designed so that it can be installed most easily by sinking it in a 65 mm electric mounting box built in the wall (**Figure 7**).

IMPORTANT WARNING! If the radiator valves in your flat are equipped with thermostat head then set the thermostat head to maximum level in the room where you intend to locate the room thermostat or replace the thermostat head of the radiator valve with manual regulating knob, otherwise the thermostat head may disturb the temperature control in the flat.

6. CONNECTION AND INSTALLATION OF THE THERMOSTAT AND PUTTING IT INTO OPERATION

Attention! Make sure that the **COMPUTHERM E300** thermostat and the apparatus to be controlled are de-energized

while putting them into operation. The device should be installed and put into operation by a competent person! If you do not possess the necessary skills and qualifications, please get in touch with an authorized service.

Caution! The modification of the device poses a risk of electric shock or breakdown!

6.1. Connection of the device(s) to be controlled

For controlling a one-zone heating/cooling system

The heating/cooling devices to be controlled should be connected to the terminal block located on rear side of the product. In the thermostat there are two potential free relays whose normally-opened connection points are at legends **K1 COM-NO (3-4)** and **K2 (8-9)** of the terminal block. When the thermostat gives a switch signal then it will switch both potential free relays, and closes the two connections points of **K1 COM-NO (3-4)** and **K2 (8-9)** separately. The connection points for the room thermostat of the heating or cooling device(s) to be controlled must be connected here. (**Figure 3**).

If the device to be controlled has no thermostat connection point, the power supply cable of the device to be controlled

should be cut off and connected to connection points **K1 COM-NO (3-4)** or **K2 (8-9)** of the thermostat (**Figure 4**).

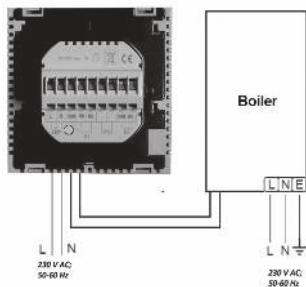

Figure 3

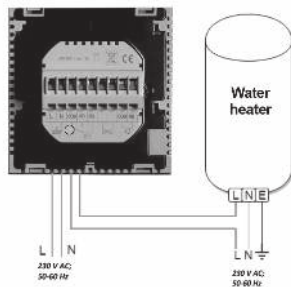

Figure 4

For controlling a multi-zone heating/cooling system

Within the loadability limits the two parallel operating relays built in the thermostat make simultaneous actuation (open/close, start/stop) of other electrically operable fittings (e.g. zone valve, pump) possible, in addition to starting up the boiler. Thus, using several **COMPUTHERM E300** type Wi-Fi thermostats,

a heating system can be easily divided into zones without a separate zone control system. For example, if you wish to install several thermostats within a heating network, in addition to controlling the boiler the zone control (opening/closing various heating zones) can be ensured without a separate zone control system, by connecting boiler control outputs **K1 COM-NO (3-4)** in parallel and connecting zone valves to **K2 (8-9)** connections points of the thermostats (Figure 5).

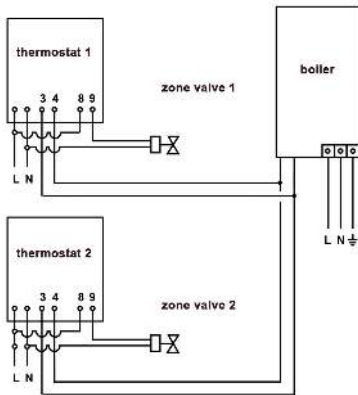



Figure 5

6.2. Connecting the floor temperature sensor

A floor temperature sensor is also included in the packaging of the thermostat. If during operation you wish to use the floor temperature sensor instead of or in addition to the temperature sensor built in the thermostat then connect it to the connection points labelled „**Sensor**” (6-7) of the terminal block located on the rear side of the thermostat.

Using the floor temperature sensor the output(s) can be controlled on the basis of temperatures measured by this sensor. On the other hand, with the help of this sensor you can set a maximum temperature, and the thermostat switches off the outputs whenever this temperature is reached. This function may be especially useful, for safety reasons, for underfloor and electrical heating systems. If you wish to use the sensor to measure floor temperature, we propose to put the temperature sensor in a short copper pipe and sink it into the floor so that it can be replaced easily when a breakdown occurs.

If you connected also a floor temperature sensor to your thermostat and you have chosen the sensor of the thermostat so that the main sensor is the built-in temperature sensor, and you use the floor temperature sensor as a safety sensor (**2 / In-s control, Out-s limit**) (see **Sub-chapter 10.1**) then you can check the temperature

measured by the floor temperature sensor in the application at the place shown in **Figure 2**. You can view this temperature on the thermostat by touching  and  icons at the same time. Now the Floor Temperature appears instead of the Room Temperature on the display of the thermostat. The temperature displayed on the thermostat will return to the Room Temperature approximately 10 seconds after you touched any button of the thermostat.

6.3. Connection to the electrical network

The product should be connected to the 230 V network through a two core cable. Power supply should be connected to points **N** and **L** of the terminal block located on the rear side of the thermostat. You do not have to take care of phase correctness during the connection process (**Figure 3**). It is not necessary to connect a ground wire because the product is double insulated.

6.4. Mounting the thermostat

To install the thermostat you should separate the front plate from the black plate. To do so, slide the front plate of the thermostat upwards and slide the rear part of the product downwards at the same time (**Figure 6**). Following this, place the rear part of the product into the 65 mm electric wall mount box then secure it by screws (**Figure 7**). Finally, slide back the front plate of the product into the black plate.



Figure 6

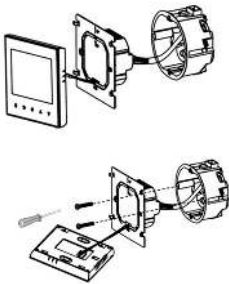

Figure 7

7. SETTING UP THE INTERNET CONTROL

7.1. Installing the application

The thermostat can be controlled by both a smartphone and a tablet with the help of free application **COMPUTHERM E Series**. Application **COMPUTHERM E Series** can be downloaded to **iOS** and **Android** operating systems. The applications are accessible through the following link or using a QR code:

https://computherm.info/en/wi-fi_thermostats







Attention! In addition to English, the application is also available in Hungarian and Romanian languages, and is automatically displayed in the language corresponding to the default settings of the phone (in case of default settings are other than these three languages, it is displayed in English).

7.2. Connecting the thermostat to a Wi-Fi network

To be able to control the device remotely, you need connected it to the Internet via a Wi-Fi network. The already configured **COMPUTHERM E300** can work according to a pre-set program without the need for a permanent Internet connection.

Attention! The thermostat can only be connected to a 2.4 GHz Wi-Fi network.

To complete the synchronization, follow these steps:

- On your phone/tablet switch on Wi-Fi connection.
Join to the 2.4 GHz Wi-Fi network to be used for the thermostat.
- Activate the positioning (GPS location) feature on your phone.
- Start the **COMPUTHERM E Series** application.
- Give all the requested permissions to the application in order to work properly.
- Turn off the device by tapping  button on the thermostat.
- Touch and hold the  button for approx. for 10 seconds until the  symbol on the display flashes quickly.
- Now touch the “**Configure**” icon in the right bottom corner in the application.
- On the page that appears, the name of the Wi-Fi network you want to use is displayed (if not, make sure your phone is connected to that Wi-Fi network, the application has all the necessary permissions and the GPS location is turned on). Enter the network password then tap the „Connect” icon.
- The connection has been established successfully between the thermostat and the Wi-Fi network when on the display of the thermostat the  symbol starts to illuminate continuously.

7.3. Connecting the thermostat to the application

- You can search for **COMPUThERM E series** thermostats connected to the Wi-Fi network concerned by tapping the “**Search**” icon in the left bottom corner (i.e. this requires that the thermostat is connected to the same Wi-Fi network used for the phone).
- On the appearing page “**Search List**” you can choose the thermostat you wish to assign to the installed application. Touching the name of the thermostat concerned, it is assigned to the application and from now on the thermostat can be controlled from anywhere. Following this, on the start screen of the application all assigned thermostats appear, together with currently measured (**PV**) and set (**SV**) temperatures.

7.4. Controlling the thermostat by multiple users

When several users wish to control the same thermostat, after the thermostat has been put into operation the following steps should be carried out to add further users:



- Connect your smartphone/tablet to the Wi-Fi network to which the **COMPUThERM E300** thermostat has been connected.

- On the apparatus you want to use for controlling download then start application **COMPUThERM E Series**.
- Tapping the “**Search**” icon in the left bottom corner, the phone/table will search **COMPUThERM E Series** thermostats connected to the Wi-Fi network concerned.
- On the appearing page “**Search List**” you can choose the thermostat you wish to assign to the installed application. Touching the name of the thermostat concerned, it will be assigned to the application, and from now on the thermostat can be controlled from anywhere. Following this, on the start screen of the application all assigned thermostats appear, together with currently measured (**PV**) and set (**SV**) temperatures.

Attention! If you want to avoid that other users can add your **COMPUThERM E300** thermostat to their phone applications, you can disable this operation as described in Sub-chapter 9.2.

8. BASIC OPERATION OF THE THERMOSTAT

When switched on, the thermostat controls the connected device(s) (e.g. gas boiler, pump) based on the measured and currently set (manually or programmed) temperature, the switching sensitivity of the thermostat (factory default ± 0.2 °C). This

means that if the thermostat is set to heating mode and 22 °C, at a switching sensitivity of ± 0.2 °C, the thermostat's output relays **K1 COM-NO (3-4)** and **K2 (8-9)** will be closed separately. The connection points close at temperatures below 21.8 °C and opened at temperatures above 22.2 °C (heating off). In cooling mode, the thermostat's relays switch exactly the opposite way. The closed status of the **K1 COM-NO (3-4)** and **K2 (8-9)** connection points of the output relays is indicated by the  or  icon on the device's display and in the telephone application according to the selected operating mode.

Attention! Keep in mind that in case of a power outage any setting of the thermostat will be stored on an external server therefore updating of data on the server takes a few seconds. Accordingly, when you modify some setting of the thermostat (operation-related setting, programming, set temperature, etc.) and the power supply of the device is interrupted within a few seconds, the modified settings will not necessarily be saved.

9. BASIC SETTINGS

After the application has been started, **COMPUTHERM E series** thermostats assigned to the application concerned appear on page “**My Thermostat's**”.

9.1. Renaming the thermostat assigned to the application

To modify the default name of the thermostat tap and hold the thermostat concerned within the application until a pop-up window with the name of “**Edit thermostat**” appears. Here you can modify the name of the thermostat within the application by tapping the “**Modify current thermostat**” icon.

9.2. Disabling further connections of the thermostat assigned to the application

If you want to prevent other users from assigning the thermostat to their phone applications then tap and hold the thermostat concerned within the application until a pop-up window with the name of “**Edit Thermostat**” appears. Tapping the “**Lock current thermostat**” icon, here you can disable matching the application for other users. Until this function is unlocked the thermostat can only be used by users who have already added the device to their application, and new users will not be able to join the device through the Wi-Fi network.

Attention! When a phone/tablet has already been connected to the Wi-Fi network concerned and application **COMPUTHERM E Series** has been opened on it then addition of the thermostat to this phone/tablet cannot be disabled with function “**Lock current thermostat**” any longer.

9.3. Deleting the thermostat assigned to the application

If you want to delete the assigned thermostat from the application then tap and hold the thermostat concerned within the application until a pop-up window with the name of **“Edit Thermostat”** appears. Here you can delete the thermostat from the application by tapping the **“Delete current thermostat”** icon.



9.4. Setting the day and time



- Using phone application:

To set date and time click on the  icon in the phone application after the thermostat has been selected. Now the thermostat sets date and time automatically via Internet.



- On the thermostat:

While the thermostat is on, tap the  button on the thermostat. Then the numbers indicating the hour are flashing on the display.

With the help of the   buttons set the exact hour then tap the  button again. Then the numbers indicating the minute are flashing on the display.

With the help of the   buttons set the exact minute



then tap the  button again. Then one of the numbers 1 2 3 4 5 6 and 7, which indicate the days of the week, will be flashing.

With the help of the   buttons set the day. By tapping the  button again the thermostat will be reset to its initial state.



9.5. Locking operating buttons



You can change the operation of the key lock function as described in **Chapter 10**. You can lock the control buttons as follows:

- Using phone application:

To lock operating buttons tap the  icon in the phone application after the thermostat has been selected. Henceforward the device cannot be controlled by the touch buttons on the thermostat until the operating buttons are unlocked. To unlock the operating buttons tap the  icon again in the phone application.





- On the thermostat:





While the thermostat is turned on, tap and hold the  button for long (for approx. 10 seconds) until the  icon appears

on the display of the thermostat. Henceforward the device cannot be controlled by the touch buttons on the thermostat until the operating buttons are unlocked. To unlock the operating buttons tap and hold the  icon for long (for approx. 10 seconds) until the  icon disappears on the display of the thermostat.

10. OPERATION-RELATED SETTINGS

For the operation of the thermostat some functions can be set. Operation-related settings can be performed in the following way:

- Using phone application:
 - Tap the  icon in the right bottom corner, then the advanced settings menu of thermostat, where you can modify the settings, will appear.
- On the thermostat:
 - Turn off the device by tapping the  button.
 - Tap and hold the  button and, at the same time, touch the  button for a short time.
 - Now you enter the settings menu: in the left bottom corner „*SET*” appears and the set temperature will be replaced by numbers .

- Tapping the  button you can switch between the functions to be set.
- A given function can be set by   arrows.
- To exit the settings menu and save the settings:
 - turn off and turn on the device using the  button, or
 - wait 15 seconds until the thermostat's display returns to the basic screen, or
 - scroll through the settings using the  button.

The setting options are shown in the table below:



Display	Function	Setting Options	Default Setting	Detailed Description
SEN	Selecting the temperature sensor	00: Internal sensor	00	Chapter 10.1
		01: Floor temperature sensor		
		02: Internal and floor temperature sensors		
DIF	Selecting switching sensitivity	0.1 - 1.0 °C	0.2 °C	Chapter 10.2
OSV	Setting the floor temperature sensor limit	5 - 99 °C	42 °C	Chapter 10.3
FLD	Selecting switch sensitivity for floor temperature	1 - 9 °C	2 °C	Chapter 10.3
SVH	Defining maximum settable temperature	5 - 99 °C	35 °C	----
SVL	Defining minimum settable temperature	5 - 99 °C	5 °C	----
ADJ	Calibration of the temperature sensor	-3 - +3 °C	0 °C	Chapter 10.4
FRE	Antifreezing	00: OFF	00	Chapter 10.5
		01: ON		
PON	Memorizing ON/OFF status in case of a power failure	00: OFF	01	Chapter 10.6
		01: ON		
LOC	Selecting the keylock function	01: only On/Off button works	02	-
		02: all button works		
FUN	Changing between heating and cooling mode	00: heating	00	Chapter 10.7
		01: cooling		
FAC	Resetting to factory default	00: Resetting to factory default 08: Saving settings	08	Chapter 10.8

10.1. Selecting the temperature sensor (SEN)

Attention! This function is only available if the floor temperature sensor is connected to the thermostat.

During the use of the thermostat the temperature sensor you want to use can be chosen. In the base case the thermostat displays the measured temperature on the basis of the built-in temperature sensor and switches the set output(s) according to the set temperature. A floor temperature sensor can also be connected as described in **Sub-chapter 6.2**. If you have connected a floor temperature sensor, you have the following choices:

- You use the built-in temperature sensor for the control (**00 / In-s control**)
- You use the floor temperature sensor for the control (**01 / Out-s control**)
- You use the built-in temperature sensor for the control but the output will be switched out with the floor temperature sensor when the set floor temperature is reached. This mode may be especially useful, for safety reasons, for underfloor and electrical heating systems, because it helps protect the heating system against possible damages/overheating (**02 / In-s control, Out-s limit**)

If you have connected also a floor temperature sensor to your thermostat and you have chosen the sensor of the thermostat so that the main sensor is the built-in temperature sensor, and you use the floor temperature sensor as a safety sensor (**02 / In-s control, Out-s limit**) then you can check the temperature measured by the floor temperature sensor in the application at the place shown in **Figure 2**. You can view this temperature on the thermostat by touching  and  icons at the same time. Now the Floor Temperature appears instead of the room temperature on the display of the thermostat. The temperature displayed on the thermostat will return to the room temperature approximately 10 seconds after you touched any button of the thermostat.

10.2 Selecting switching sensitivity (DIF)

It is possible to set the switching sensitivity. By setting this value, you can specify how much the appliance switches the connected device on/off below/above the set temperature.

The lower this value, the more uniform the internal room temperature, the greater the comfort is. The switching sensitivity does not affect the heat loss of the room (building).

In case of higher comfort requirements, the switching sensitivity should be chosen so as to ensure the most constant in-

ternal temperature. However, also make sure that the boiler is switched on several times an hour only at low outdoor temperatures (e.g. $-10\text{ }^{\circ}\text{C}$), as frequent switching off and on will impair the efficiency of the boiler's operation and increase gas consumption.

The switching sensitivity can be set between $\pm 0.1\text{ }^{\circ}\text{C}$ and $\pm 1.0\text{ }^{\circ}\text{C}$ (in $0.1\text{ }^{\circ}\text{C}$ increments). Except some special cases, we recommend setting $\pm 0.1\text{ }^{\circ}\text{C}$ or $\pm 0.2\text{ }^{\circ}\text{C}$ (factory default setting). See **Chapter 8.** for more information about switching sensitivity.

10.3. Setting floor temperature limit (OSV) and corresponding switch sensitivity (FLD)

If you have chosen setting of internal and floor sensors (**02 / In-s control, Out-s limit**) at menu item "**Selecting temperature sensor**" (**SEN**), a maximum temperature can be set for the floor temperature sensor. When the temperature measured by the floor temperature sensor reaches the set value, the thermostat disables its outputs (switches them out regardless of the temperature set on the thermostat) until the temperature cools down below the set temperature, considering the switch sensitivity set for the floor temperature (**FLD**). This means that when the **OSV** value is set to $42\text{ }^{\circ}\text{C}$ and the **FLD** value to $2\text{ }^{\circ}\text{C}$, the outputs of the thermostat will be disabled when the temperature

measured by the floor temperature sensor reaches 44 °C, and the outputs will resume normal operation only after the temperature measured by the floor temperature sensor goes below 40 °C.

10.4 Calibration of the temperature sensor (ADJ)

The measuring accuracy of the thermometer of the thermostat is ± 0.5 °C. The temperature displayed by the thermostat can be modified in steps of 0.1 °C in comparison to the temperature measured by the temperature sensor, but the modification must not exceed ± 3 °C.

10.5. Antifreezing (FRE)

When the antifreezing function of the thermostat is activated, the thermostat will switch on its output, regardless of any other setting, when the temperature measured by the thermostat goes below ± 3 °C. When the temperature reaches 7 °C, normal operation of the output is restored (according to the set temperature).

10.6. Memorizing ON/OFF status in the case of a power failure (PON)

By means of the Memorizing Settings function of the thermostat you can select the mode in which the thermostat continues to operate:



- **00/OFF**: the thermostat turns off and remains turned off until this mode is altered, regardless whether the thermostat was on or off before the power failure.
- **01/ON**: the thermostat returns to the same state in which it was before the power failure (default setting).

10.7 Changing between heating and cooling mode (FUN)

You can easily switch between heating (**00**; factory default) and cooling (**01**) modes.

The connection points **K1 COM-NO (3-4)** and **K2 (8-9)** of the thermostat output relay **close at a temperature below the set temperature in heating mode and at a temperature above the set temperature in cooling mode** (taking into account the set switching sensitivity).

10.8 Restoring default setting (FAC)

All settings of the thermostat, except for date and time, will be restored to factory setting. To restore factory setting, after selecting *FAC* setting option and tapping the  button several times, switch over the appearing *00* setting to *00*. Then tap the  button once to restore factory setting. If you move on by tapping the  button and leaving the *FAC* value at its default

value () then the device will not return to default setting but save the settings and exits the operation-related settings menu.



Attention! Keep in mind that in case of a power outage any setting of the thermostat will be stored on an external server, therefore updating of data on the server takes a few seconds. Accordingly, when you modify some settings of the thermostat (operation-related setting, programming, set temperature, etc.) and the power supply of the device is interrupted within a few seconds, the modified settings will not necessarily be saved.

11. SWITCHING BETWEEN ON AND OFF POSITIONS AND MODES OF THE DEVICE

The thermostat has the following 2 positions:

- **Off position**
- **On position**

You can switch between off and on positions in the following way:

- Using phone application: by tapping the  icon
- On the thermostat: tapping the  button



When the thermostat is off, the screen of the devices turns off and in the application **POWER-OFF** lettering replaces measured and set temperatures, and the relay outputs of the de-

vice go into off (open) position. When the thermostat is on, the display of the device illuminates continuously. If you touch the touch buttons or modify the settings of the thermostat with the phone application, the light intensity on the thermostat gets higher for approx. 10 seconds then falls back to basic level.











When the thermostat is on, it possesses the following 2 modes of operation:

- Manual mode
- Programmed auto mode

You can switch between the modes in the following way:

- Using phone application: by touching  or  icons
- On the thermostat: touching the 

The currently selected mode is indicated as follows:



- In the phone application: manual mode by the  icon and programmed auto mode by the 
- On the thermostat: manual mode by the  Manual icon programmed auto mode by one of the following icons       (according to the current switching scheme) and by the  AUTO icon.

The two modes are described in detail in the following sub-chapters.

11.1. Manual mode

In manual mode the thermostat maintains a preset temperature until the next intervention. If the room temperature is lower than that set on the thermostat, the output of the thermostat will switch on. If the room temperature is higher than that set on the thermostat, the output of the thermostat will switch off. The temperature to be maintained by the thermostat can be specified in 0.5 °C steps (the minimum and maximum values of the adjustable range are 5 °C and 99 °C, respectively).

The currently set temperature can be modified in the following way:

- Using phone application:
 - with the  icons
 - moving the slide (groove) on the circular scale
- On the thermostat: with the  buttons

11.2. Programmed auto mode

11.2.1. Description of the programmed mode

Programming means setting of switching times and selection of corresponding temperature values. Any temperature set for a switch will remain in effect until the time of the next switch. Switching times can be specified with an accuracy of 1 minute. Within the temperature range (the minimum and maximum val-

ues of the adjustable range are 5 °C and 99 °C, respectively) specified in the settings a different temperature can be chosen for each switching time, in 0.5 °C steps.

The device can be programmed for a period of one week. In the programmed auto mode the thermostat operates automatically, and cyclically repeats the entered switches every 7 days. The following 3 options are available to program the thermostat:

- **5+2 mode:** setting 6 switches per day for 5 working days and 2 switches per day for 2 days of the weekend
- **6+1 mode:** setting 6 switches per day from Monday till Saturday and 2 switches on Sunday
- **7+0 mode:** setting 6 switches per day for every day of the week

If you do not need all adjustable switches on certain days (e.g. only 4 switches is required on working days), you can eliminate unnecessary switches by setting their time and temperature to the time and temperature of the last switch you want to use.

11.2.2. Description of the steps of programming

- **Using phone application:**

- a) To enter programming mode touch the  icon. Then the screen for programming appears on the display.

b) The indication of the currently selected programming mode is located at the top of the screen for programming, beside the legend **Week Loop**. Touching this, you can switch between programming modes as follows:

- **12345,67**: 5+2 mode
- **123456,7**: 6+1 mode
- **1234567**: 7+0 mode

c) Switches belonging to a given programming mode are below the indication of the programming mode. You can modify data (time, temperature) of switches by tapping the value concerned.

d) To complete programming and return to the screen belonging to the thermostat touch the < icon in the upper left corner.

Programs that were set earlier can be checked at any time by entering the programming mode again.

- **On the thermostat:**



a) To enter programming mode touch the  button for approximately 5 seconds. Then on the display the legend **LOOP** appears in place of the hour, and the indication belonging to the currently selected programming mode replaces the current day.

b) With the \triangle / ∇ buttons choose the preferred programming mode as follows:

- for **5+2 mode: 12345**
- for **6+1 mode: 123456**
- for **7+0 mode: 1234567**

Now touch the  button again.

c) Following this, you can specify or modify various switch times and temperatures as follows:

- You can switch between switch times with the  button.
- With the help of  you can switch between data belonging to switch times (temperature, hour value of the time, minute value of the time).
- Values are always set by \triangle / ∇ buttons.









After the program of weekdays has been set, you can set the program of the days of the weekend. The day and switch being set are shown by the icon flashing on the display.

d) Programs that were set earlier can be checked at any time by repeating the steps of programming mode.



Attention! During programming, the switching times can only be changed so that they remain in chronological order.

11.2.3. Modifying temperature until the next switch in the program

If the thermostat is in programmed mode, but you want to temporarily change the set temperature until the next program switch, you can do so as follows:

- Using the phone application: by touching the   icons or moving the circular sign on the circular scale, the  icon will appear in the application instead of the  icon.
- On the thermostat: by touching the   buttons. The thermostat display will show  and  at the same time.

The temperature set in this way will remain in effect until the next program switching. The „Modifying temperature until the next switch in the program” mode is marked as follows:

- In the phone application: with the (mutatóúj ikon) icon
- On the thermostat: with the  and  icons

12. PRACTICAL ADVICES, TACKLING ANY PROBLEMS THAT MAY OCCUR

Problem with the Wi-Fi connection

When the product cannot be connected to a Wi-Fi network or cannot be controlled via the Internet because the connection between the product and the Internet interface is lost and the application indicates that the device is not available, we recommend to check the list of Frequently Asked Questions (FAQs) collected on our website and follow the steps described there.

Use of the application

The phone/tablet application is under continuous improvement. We propose to update the application to the latest version because user experience is improved continuously and new functions are accessible in the updated versions.

FREQUENTLY ASKED QUESTIONS

When you think that your appliance is operating incorrectly or encounter any problem while the appliance is being used then we recommend that you read Frequently Asked Questions (FAQ) available on our website, where we collected the problems and questions that most frequently occur while our appliances are being used, along with the solutions thereto:

<http://www.computherm.info/en/faq>



The vast majority of the problems encountered can be solved easily by using the hints available on our website, without seeking professional help. If you have not found a solution to your problem, please pay a visit to our qualified service.

Warning! The manufacturer does not assume responsibility for any direct or indirect damages and loss of income occurring while the appliance is being used.

13. TECHNICAL DATA

- Trademark: **COMPUTHERM**
- Model identifier: **E300**
- Temperature control class: **Class I**
- Contribution to the efficiency of seasonal space heating: **1 %**
- **Temperature measuring range:**
 - 0 °C - 50 °C (0.1 °C steps) - internal sensor
 - 0 °C - 99 °C (0.1 °C steps) - floor temperature sensor
- **Temperature measurement accuracy (floor and internal temperature sensors):** ± 0.5 °C
- **Adjustable measuring range:** 5 °C – 99 °C (in 0.5 °C steps)
- **Switch sensitivity:** ± 0.1 °C - ± 1.0 °C (0.1 °C steps)
- **Temperature calibration range:** ± 3 °C (in 0.1 °C steps)
- **Supply voltage for the thermostat:** 200-240 V AC; 50/60 Hz
- **Switchable frequency (K1 and K2):** Max. 24 V DC / 240 V AC
- **Switchable current:**
 - K1:** 8 A (2 A inductive load)
 - K2:** 3 A (1 A inductive load)
- **Operating frequency:** Wi-Fi (b/g/n) 2.4 GHz
- **Storage temperature:** -5°C ... +55°C

- **Operating relative humidity:** 5% - 95% without condensation
- **Protection against environmental impacts:** IP20
- **Standby power consumption:** max 0.5 W
- **Dimensions:** 86 x 86 x (17 + 33) mm
- **Mass: thermostat:** 175 g + floor temperature sensor: 60 g
- **Type of the temperature sensor (floor and internal temperature sensors):** NTC 3950 K 10 k Ω at 25 °C

The **COMPUTHERM E300** type Wi-Fi thermostat
complies with directives RED 2014/53/EU and
RoHS 2011/65/EU



Manufacturer:

QUANTRAX Ltd.

Fülemüle u. 34., Szeged, H-6762, Hungary

Phone: +36 62 424 133 • Fax: +36 62 424 672

E-mail: iroda@quantrax.hu

Web: www.quantrax.hu • www.computherm.info

Origin:

China



Copyright © 2020 Quantrax Ltd. All rights reserved.