



## HR92

Wireless  
Radiator Controller

### 1. Scope of delivery

The radiator controller packaging contains:

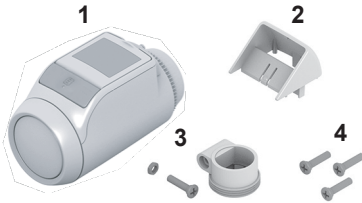

- 1 Radiator controller with valve baseplate M30 x 1.5; batteries included
- 2 Display support
- 3 Valve adapter type Danfoss RA
- 4 Screws for securing radiator controller and battery compartment

### re 2. Briefdescription



The HR92UK radiator controller is certified by eu.bac.

HR92 is an electronic radiator controller with a modern design. Because of the wireless communication with a frequency of 868 MHz the controller can be easily integrated in heating systems such as evohome to control the room temperature.

#### User-friendly

- Large adjustable display with backlight.
- Display of information in the display using symbols and text.
- Parameters can be set individually.
- Manual temperature modification (effective until the next switching point) possible at any time.

#### Mounting

- The radiator controller fits on the most common radiator valves of the type M30x1.5.
- Further adapters are available as accessories.
- An external window contact can be connected optionally.

#### Energy saving features

- With the window function, the radiator valve is closed when ventilating the room.
- If an external window contact is used, the radiator valve is closed when a window is open.



Use the radiator controller only in accordance with these operating instructions.

**CAUTION** Do not let children play with the radiator controller.



WARNING

Danger of suffocation!  
Keep packaging materials away from children.

### 3. Device overview

#### Operating elements and display

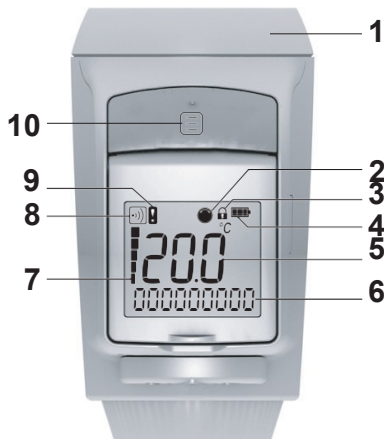

- 1 Adjustment dial
- 2 Displays that the room setpoint was changed manually
- 3 Operationlock
- 4 Battery status
- 5 Temperature display/parameter information
- 6 Text display, 9characters
- 7 Radio signal (field strength)
- 8 Radio communication display
- 9 Radio communication error
- 10 Info button, for displaying the room (zone) information;  
Function button, for binding and configuring

#### Battery display

Battery status	Meaning
	Batteries fully charged
	Batteries half charged
	Batteries have to be replaced soon
	Flashing display: Batteries are dead and have to be replaced

### Radio signal display

Display	Meaning
	Field strength excellent
	Field strength good
	Field strength weak

### 4. Mounting

Ready to operate in three steps:

- Insert batteries and set language
- Establish radio connection
- Mount on radiator controller – FINISHED

#### Inserting/changing batteries

The radiator controller is set for the following battery type:

- 2 alkaline cells 1.5 V; type LR6, AA, AM3
- You can instead use the following batteries or rechargeable batteries:
- Lithium 1.5 V; type LR6, AA, AM3
  - NiMH 1.2 V; type LR6, AA, AM3

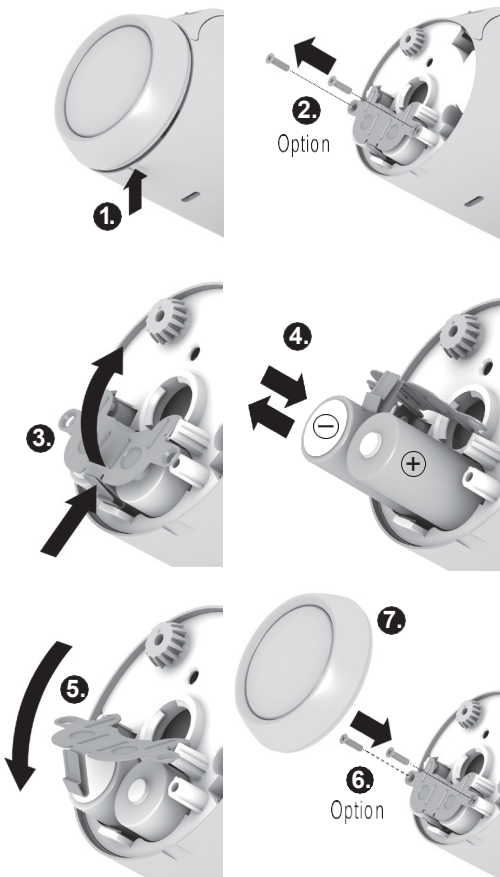

- i** • If lithium or NiMH batteries are used, Parameter 9 has to be adapted, see Section 5.
- Always change batteries in pairs.

- i** • If the batteries are too weak, the radiator controller opens the radiator valve completely.
- After the batteries have been replaced, the radio connection to the central operating device is restored automatically.



1. Pull off the adjustment dial. To do so, start at the notch on the bottom of the device.
2. If used, unscrew any fastening screws from the battery compartment.
3. Release the lock and fold out battery spring.  
*The battery compartment is now accessible.*
4. Insert the batteries.  
Ensure that the polarity "+" and "-" is correct.
5. Fold down the battery spring and latch it in.
6. Option: Secure the battery spring with the fastening screws to secure the batteries against theft.
7. Place the adjustment dial back on.  
*First the software version number and then the language english is displayed.*
8. If desired, use the adjustment dial to select a different language.
9. Confirm the selected language with the  button.

 The language selection is only displayed during initial commissioning.

 The battery life of new alkaline cells amounts to approx. 2 years. The batteries need changing when the symbol  flashes. All the settings are retained when the batteries are changed.





WARNING

Explosion hazard!  
f Never charge non rechargeable batteries.  
f Never short-circuit batteries or throw them into fire.  
f Dispose of used batteries ecologically.

## Establishing radio connection

The radiator controller HR92 communicates with the central operating device by radio using the frequency of 868 MHz. To this purpose the connection between the HR92 and the central operating device has to be established first. This process is called BINDING. In the case of preconfigured devices binding has already been carried out in the factory.





 If binding has not yet been carried out, unbound is displayed after  has been pressed.

Binding must first be activated at the HR92 so that the radio signal can be received. Subsequently binding has to be activated at the central operating device.

 Please read the operating instructions of your central operating device for further information about binding.

## Activating binding at the HR92

 Carry out binding of the radiator controller near the final mounting location.

1. Press the  button briefly.  
*unbound is displayed.*
2. Hold the  button pressed for 5 seconds.  
*bind is displayed.*
3. Press the  button briefly.  
*binding is displayed and the radio symbol  appears.*

## Activating binding at the central control device

 To activate binding at the central control device: see the associated instructions.

## Binding at the HR92

The radio symbol  flashes during binding. If binding was successful, **success** is displayed. Afterwards the main display is shown. When **sync** is shown in the display, the radiator controller is synchronizing with the central operating device.

HR92 receives the data from the central operating device.

**i** Synchronization can take up to 4 minutes until the current room setpoint temperature is displayed at the HR92.

If **BINDING** is not successful, it is terminated automatically after approx. 10 minutes. – or – To cancel **BINDING**, select **Exit** using the adjustment dial and confirm with the  button.

**i** If several HR92 radiator controllers in one room (zone) are to be controlled by the central operating device, it is possible to activate **BINDING** at all radiator controllers simultaneously. **BINDING** then only has to be carried out once.

## Failed binding/insufficient data transfer

Binding has failed when the radio symbol  disappears and **failed** is displayed.



The data transfer output may be insufficient. This can be caused by metallic objects or further radio devices.

**f** Ensure that the distance to radio devices such as radio headphones, cordless phone, etc. amounts to at least 1 m.



**f** Ensure that the distance to metallic objects is sufficient.

**f** If radio interference cannot be eliminated, select a different mounting location for the room unit and repeat binding.

## Clearing binding at the HR92

1. Press the  button briefly.
2. Hold the  button pressed for 5 seconds.
3. Select **bind** using the adjustment dial and keep the  button pressed until **cleared** is displayed. *Binding is deactivated.*

## Radio test

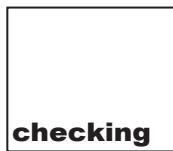

1. Press the  button briefly.
2. Hold the  button pressed for 5 seconds.
3. Select **rf check** using the adjustment dial and confirm with the  button. *checking is displayed (flashing) in the display.*



*The radiator controller is ready to receive radio signals from the central operating device.*



**i** Please read the operating instructions of your central operating device for further information about the radio test.

*The field strength is displayed as a bar and a number while the radio signal is being received.*

	5 bars	Field strength excellent
	3 bars	Field strength good
	1 bars	Field strength weak

## Radio test at operating devices with 2-way communication

If the central operating device can transmit and receive (2-way communication), like the evotouch, the field strength can be queried directly at the radiator controller without activating the radio test in the central operating device.

1. Press the  button briefly.
2. Hold the  button pressed for 5 seconds.
3. Select **rf check** using the adjustment dial and confirm with the  button. *checking is displayed (flashing) in the display.*

4. Press the  button again.

*The field strength is displayed as a bar and a number while the radio signal is being received.*



## Interrupting the radio test

The radio test is terminated automatically after approx. 10 minutes.

– or –

Press **exit** using the adjustment dial and confirm with the  button.

## Radio communication error

If the exclamation mark  and the radio symbol  flash during normal operation, an error has occurred during radio communication.

- The room setpoint temperature of the HR92 radiator controller is changed automatically to 20 °C.

Restore radio communication to the central operating device, see Section 7.

## Mounting the radiator controller

The radiator controller can be mounted on all common thermostatic valves with an M30 x 1.5 connection without draining system.



**WARNING**

Prevent damage to the radiator controller through humidity and moisture!  
Mount the radiator controller indoors only.

Protect the radiator controller against humidity, moisture, dust, direct sunlight or exposure to excessive heat.

## Removing the old thermostat head

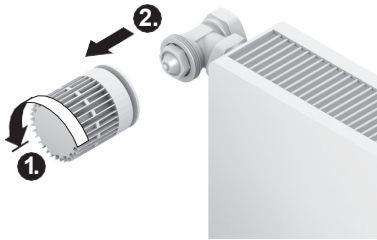



- Turn the old thermostat head anti-clockwise until it stops and loosen the mounting ring.
- Remove the old thermostat head from the radiator valve.

## Selecting the adapter

The radiator controller fits on common radiator valves of the type M30 x 1.5. Adapters are required for some valve types.

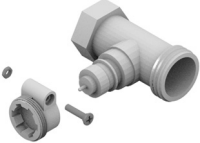
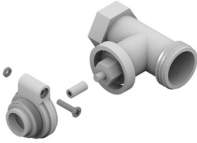
- Check whether an adapter is required and, if necessary, select the appropriate adapter.

Brand	Illustration	Adapter
Honeywell Home-Braukmann, MNG, Heimeier, Oventrop valves M30 x 1.5		Not required
Danfoss RA		Supplied
Danfoss RAV		*
Danfoss RAVL		*

\* can be ordered under EVA1-Danfoss

- Slide the adapter onto the radiator valve and turn it until you feel it click into place.
- If necessary, screw the adapter tight with a screw.

## Mounting the valve baseplate

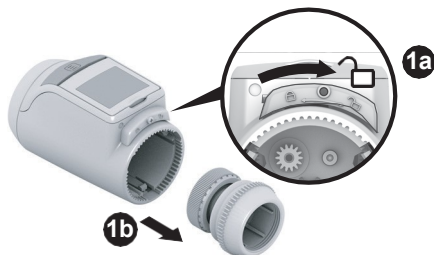

1. Separate the valve baseplate from the radiator controller. To do so, push the slide towards .

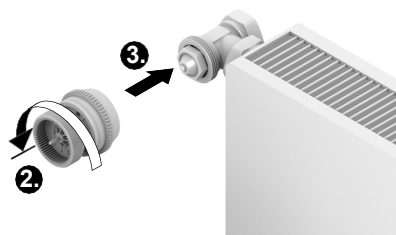

2. Turn the adjustment dial of the valve baseplate anti-clockwise until it stops.
3. Put the valve baseplate onto the radiator valve or the adapter and tighten by hand (without tools!).

## Mounting the radiator controller

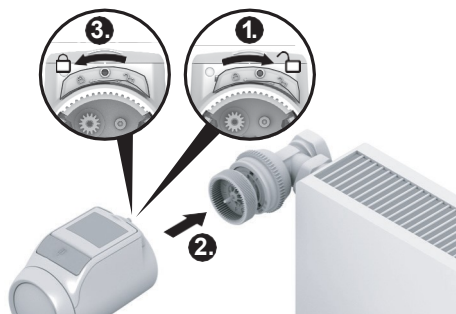

1. Ensure that the slide on the radiator controller is in the open position.
2. Put the radiator controller onto the valve baseplate so that the indentation latches in and is no longer visible.

3. Lock the radiator controller in the end position. To do so, push the slide towards .

*After approx. 1 minute cycl (self-test) is displayed. Afterwards the radiator controller changes to normal operation.*

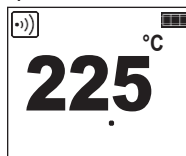

**i** The radiator controller only operates if it is locked correctly in the end position.

**FINISHED!** – The radiator controller now controls the room temperature in accordance with the specification of the central operating device.

## Securing the radiator controller

- i** The radiator controller and the batteries can be secured against removal by using the supplied screws.

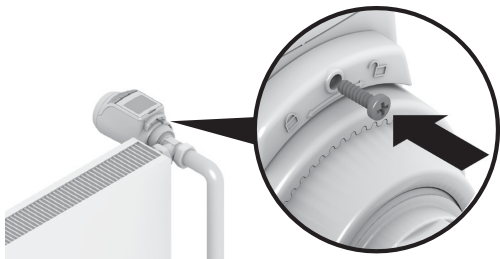

## Setting the position of the display

In order to improve the legibility the display of the radiator controller can be tilted to different positions (10°, 20°, 30°, 40°). The angle of 40° can be fixed with the supplied display support.

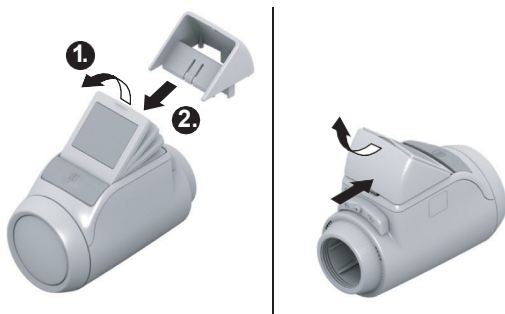

## Mounting

1. Lift the display and set it to the desired angle.
2. If desired, tilt the display by 40° and slide the display support from above between the display and the housing until it latches in.

## Unmounting

- f** Press the display support in at the back and remove it upwards.

## Connecting an external window contact

The floating external window contacts HCA30 can be connected to the HR92 radiator controller.

- i** The cable ACS90 is required to connect the external window contact.
- Micro B mini-plug / open ends
  - 2 m long
  - Not included in the scope of delivery

## Operation with window contact

When the window is opened, the window contact is opened and the radiator valve closes. When the window is closed again, the radiator controller returns to normal operation.

The frost-protection function ensures that the radiator valve opens when the temperature drops below 5 °C.

- i** If a cabled window contact is removed, Parameter 11 has to be modified to 0 or 1, see Section 5.

## Cable connection

**f** Connect cable ACS90 as follows to the window contact HCA30:

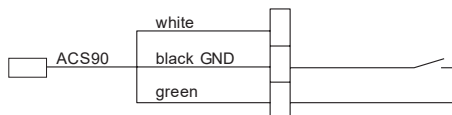

## Connecting the cable to the radiator controller HR92

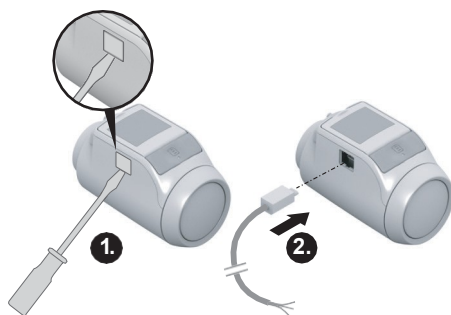

1. Remove the side cover from the radiator controller.
2. Insert the cable ACS90 into the radiator controller HR92.

*The radiator controller recognises the connected window contact automatically.*

## 5. Basic settings

### Overview

If required, the 12 basic settings (parameters) can be adjusted.

Factory settings have a grey background.

Parameters marked with an \* are described in more detail below.

Par.	Set-ting	Meaning
1		Language setting
	1	English
	2	German
	3	Italian
	4	French
	5	Dutch
	6	Spanish
2	0	Backlight * Deactivated
	1	Activated
3	0	Duration of the window function * Window function not active
	30	Valve opens at the latest after 30 minutes
	...	...
	90	Valve opens at the latest after 90 minutes
4		Sensitivity of the window function during dropping room temperature *
	0.2	0.2 (sensitive)
	...	...
	2.0	2.0 (less sensitive) Factory setting: 0.4
5		Sensitivity of the window function during rising room temperature *
	0.1	0.1 (sensitive)
	...	...
	2.0	2.0 (less sensitive) Factory setting: 0.2
6	0	Setting the valve stroke * Standard valve stroke
	1	Full-stroke mode
7		Temperature representation in the display *
	0	Set/programmed temperature (setpoint temperature)
	1	Measured room temperature
8		Temperature offset *
	3	To adjust the temperatures measured by the radiator controller and in the room
	...	...
	-3	Factory setting: 0



Par.	Set-ting	Meaning
9		Battery type
	0	Alkaline
	1	Lithium
	2	NiMH (rechargeable batteries)
10		Display of the valve position *
	0	No display of the valve position
	1	Momentary display of the valve position
11		Window open function *
	0	Off (no window function)
	1	Auto (corresponding to Parameters 3-5)
	2	Cabled (with floating window contact)
12	0	Restore to factory setting No reset
	1	Reset
		The binding is retained.
		Exit

### Changing parameters

1. Keep the  button pressed for approximately 5 seconds until Parameter 1 flashes (left-hand digit).



The right-hand digit shows the current setting. The parameter is displayed additionally in plain text. For example, the display  $1^1$  stands for Parameter 1 (language) with Setting 1 (German).

2. Use the adjustment dial to select the desired parameter (left-hand digit).
3. Press the  button to edit the parameter.  
*The current setting of the parameter flashes (right hand digit).*
4. Use the adjustment dial to set the desired setting (right-hand digit) and confirm with .  
*The parameter being edited flashes (left-hand digit).*
5. For the further parameters repeat Steps 2 to 4.
6. To exit the menu, select **exit** using the adjustment dial and confirm with the  button.



## Description of the parameters

### Parameter 2 – Backlight

The display has a backlight for reading the information.

- The backlight is ON when the adjustment dial is turned or a button is pressed.
- The backlight switches OFF if no action is carried out at the radiator controller for approx. 7 seconds in order to save battery power.

### Parameters 3 to 5 – Window function

In order to save energy the radiator controller closes the radiator valve when you open a window resulting in a large drop of the temperature.

When you close the window so that the temperature rises the radiator controller opens the radiator valve again.

When the duration of the window function (factory setting: 30 minutes) has expired, the system controls to the current room setpoint temperature again. Frost protection is ensured during the window function.

### Parameter 6 – Valve stroke

The radiator controller operates with the optimum valve stroke set in the factory.

If the entire valve stroke is to be used or if the valve does not open completely, activate the full-stroke mode.

### Parameter 7 – Temperature representation in the display

- In the factory setting the room setpoint temperature is displayed.
- With the setting "measured temperature" the measured room temperature is displayed. A changeover to the set temperature is carried out by turning the adjustment dial or pressing the button. If required, the temperature can now be reset. The display returns to the measured temperature after approx. 3 seconds.

Due to the heat influence of the radiator the "measured temperature" displayed at the radiator controller can differ from the temperature measured at another point in the room.

### Parameter 8 – Temperature offset

Since the radiator controller measures the room temperature in the area of the radiator, it is possible that this temperature deviates from the temperature measured at a different point in the room.

If, for example, 20 °C is measured in the room and 21.0 °C at the radiator, this effect can be compensated by an offset of -1.0 °C.

### Parameter 10 – Display of the valve position

When this parameter is activated (setting "1"), the calculated valve position (0 ... 100% opened) is displayed momentarily.

The main display is shown again after approx. 3 minutes.

To cancel, select **exit** and press the  button.

### Parameter 11 – Window open function

- If a window contact is connected, the parameter is set automatically to "2" (cabled). The window function is controlled by the window contact.
- If no window contact is connected, the setting "0" or "1" has to be selected.

## 6. Further functions

### Manual changing of the room setpoint temperature

The room setpoint temperature can be changed at any time by means of the adjustment dial. The changed room setpoint temperature remains in effect until the next switching point.

The symbol  shows that the temperature was changed manually. The symbol extinguishes when the next setpoint is reached.

By turning the adjustment dial anti-clockwise until **off** is displayed, the valve will be closed permanently. With this setting the time program of the central operating device is no longer active for this radiator controller, but frost protection is guaranteed if the heating is switched on.

### Display of the room name

If the central operating device can transmit the room name (zone name), like the evotouch, the room name is displayed at the radiator controller (max. of 9 characters).

Press  button.

*The room name (zone name) is shown briefly in the display.*

## Window function

If you open a window causing the temperature to drop, the radiator controller closes the radiator valve in order to save energy.  
window is displayed.

When the temperature rises again, but at the latest after the set period (factory setting: 30 minutes), the radiator controller opens the radiator valve again.

You can also open the radiator valve beforehand by turning the adjustment dial.

The sensitivity of the radiator controller to a temperature drop or temperature rise can be set, see Section 5, Parameters 3 to 5.

If a window contact is connected, the window function reacts directly to the opening and closing of the window, see Parameter 11.

## Valve protection

If the radiator valve has not been opened once completely within the period of 2 weeks, a self-test (forced operation) is carried out. The radiator controller opens the radiator valve briefly on the subsequent Monday in order to prevent seizing.  
cycl is displayed.



## Frost protection

If the temperature drops below 5 °C, the radiator controller opens the radiator valve until the temperature rises above 6 °C again. This prevents the heating system from freezing up.  
frost is displayed.



The heating must be switched on to ensure the frost protection function.

## Errortable

Problem/Display	Cause	Remedy
 flashing	Batteries flat	Replace the batteries.
 icons are flashing	No radio communication	Check the radio connection between the HR92 and the central operating device (radio test). Repeat the binding procedure. Check the power supply to the central operating device and the HR92.
no sync	Radio connection interrupted  Parameters at the CM927/ DT92 operating device not set	Check the radio connection  CM927 operating device: Parameter 8: Set SU. DT92 operating device: Set Parameter SU (see corresponding instructions).
e1 sensor	Device defective	Replace the device.
e2 valve	Motor cannot be moved	Check the installation. If appropriate, remove the dirt.
The radiator stays hot	The radiator valve does not close fully	Check the installation. If appropriate, change to full-stroke mode (Parameter 6).
Motor does not move	Valve baseplate not interlocked	Set the slider to the position  .
The HR92 does not accept setpoint changes from the central operating device	Valve closed permanently, off is displayed	Use the adjustment dial to set the room temperature to the desired value. The next switching command from the central operating device will then be executed from the HR92.



## Emergency operation when batteries are flat

1. Unlock the radiator controller. To do so, push the slide at the radiator controller towards .

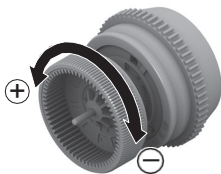
3. Operate the radiator valve by hand using the adjustment dial on the baseplate.



## Restoring the factory setting

1. Keep the  button pressed for approximately
2. Use the adjustment dial to select Parameter 12 (left-hand digit) and Setting 1 (right-hand digit).
3. Press the  button to restore the factory setting.

*The binding is retained.*

Ambient conditions

For living area, business and commercial areas as well as small businesses

Humidity

10 ... 90 % rel. humidity

Standards

EN55014-1:2006 +A2:2011  
EN55014-2:1997 +A2:2008  
EN60730-1:2011  
EN60730-2-9:2010  
EN300-220  
EN 301-489  
RoHS 2011/65/EC  
CE

## 9. Disposal

The radiator controller has to be disposed of in accordance with the Waste Electrical and Electronic Equipment directive 2012/19/EC –



f At











corr  
f Do  
usu

Type	HR92UK
Protection class	IP30
Radio communication	SRD (868.0 ... 870.0 MHz) RX Class 2 residential buildings
Supply voltage	Battery type LR6, AA, AM3 Alkaline: 2 x 1.5 V Lithium: 2 x 1.5 V NiMH: 2 x 1.2 V
Power consumption	Standby: typ. 165 mW Control: typ. 240 mW
Control accuracy (CA)	0.5 °C
Connection to the radiator	M30 x 1.5
Ambient temperature	0 ... 50 °C
Transport and storage temperature	-20 °C ... 65 °C
Dimensions	96 x 54 x 60 mm
Weight	185 g (with batteries)

## 10. Declaration of Conformity

Hereby Honeywell Home declares that this HR92UK is in compliance with the essential requirements and other relevant provisions of Directive 1999/5/EC.

# 11. Binding and radio test – Overview

Press the  button briefly					
Display: Room information					
Hold the  button pressed for 5 seconds					
<b>bind</b>			<b>rf check</b>		<b>exit</b>
 button	Hold the  button pressed until	 button		 button	
binding *)	<b>cleared</b>	checking flashes		back to standard display	
success		 button *	Radio signal from operating device		
back to standard display		Display of the field strength			
					
		<b>exit</b>			
		 button			
		back to standard display			

 Turn adjustment dial to the right

\* Only at operating devices with 2-way communication, e.g. evotouch.